

# 600 Watt Windmill

 Bluetooth

12V / 24V

## User's Manual





# Table of Content

- 1. SAFETY** ..... 1
  - 1.1 Mechanical Hazard ..... 2
  - 1.2 Electrical Hazard ..... 2
- 2. SYSTEM SPECIFICATION** ..... 4
  - 2.1 Specification ..... 4
  - 2.2 Performance ..... 5
  - 2.3 Wiring Requirement ..... 6
- 3. SYSTEM PROTECTION** ..... 8
  - 3.1 Digital-controlled MPPT ..... 8
  - 3.2 Manual Stop Switch ..... 11
- 4. PACKAGE CONTENTS** ..... 13
- 5. INSTALLATION PROCEDURE** ..... 14
- 6. AUTOMAXX BLUETOOTH APP** ..... 21
- 7. MAINTENANCE** ..... 23
- 8. FAQs** ..... 24
- 9. TROUBLESHOOTING** ..... 28
- AUTOMAXX WARRANTY POLICY** ..... 29
- APPENDIX A IMPORTANT SAFETY INSTRUCTIONS** ..... 33
- APPENDIX B BEAUFORT WIND SCALE** ..... 36
- APPENDIX C MPPT CHARGE CONTROLLER** ..... 37
- INVESTIGATION FORM** ..... 45



# 1. SAFETY

Your wind turbine is designed with your safety as the priority. However, there are still some inherent dangers involved with any electrical and/or mechanical equipment. Safety must be the primary concern as you plan the location, installation, and operation of the turbine.

Please carefully read the following:

## **Important Safety Instructions**

Carefully go through this manual before initiating the wind turbine installation.

- (1) Keep this instruction manual safely for future reference.
- (2) Wait for a sunny day to install or for maintenance work on your wind turbine with the activation of the manual stop switch.
- (3) Listen to your wind turbine if you hear any mechanical noise, maintenance may be required, please contact the Products Customer Service.
- (4) After installation, double-check all the screws and bolts to make sure they are tightened.
- (5) Adhere to proper grounding techniques as established by the National Electrical Code (NEC).
- (6) Your wind turbine must be installed as per this user manual and the local and national building code of your region. Incorrect installation may void your warranty.
- (7) Wind turbine blades spin at a potentially dangerous speed, this must be respected. Never approach near to the turbine when it is in motion.
- (8) Note wire size (gauge chart included) before wiring. Any under-sizing of wire can be potentially dangerous.

## **1.1 Mechanical Hazard**

Rotating blades present the most serious mechanical hazard. The rotor blades are made of very strong glass fiber & polypropylene and the blades may reach velocities over 15 m/s. At this speed, the tip of the blades are nearly invisible and can cause serious injury. Under no circumstances the turbine should be installed in locations where a person could come in contact with its moving rotor blades.

## **1.2 Electrical Hazard**

The wind turbine is equipped with sophisticated electronics designed to protect from electrical dangers. Please note that the inherent personal dangers from electrical current still exist, therefore caution should always be taken while connecting this and other electrical devices. Heat in a wiring system is often a result of excessive current flowing through an undersized wire or a weak/damaged connection. Please consult the wire guide table below.

Batteries can deliver a dangerous amount of current. If any short circuit occurs in the wiring from the batteries, can result in a fire break-out. To avoid this threat, a properly sized fuse or circuit breaker is required in the lines connecting to the battery.

## **Choosing your wind turbine's location**

Before the installation of your wind turbine, you must carefully consider a location. Things to consider when selecting your wind turbine location.

(A) Height and Distance from obstacles like buildings, trees:

- Install the wind turbine in open and windy sites so, the turbine will be exposed to winds properly and the benefit can be maximized. A distance of 7-10m should be maintained.
- The minimum recommended tower height is 22 ft (7 m) to 33 ft (10 m). The wind speed below 22 ft (7 m) constrained by the terrain is low and chaotic.

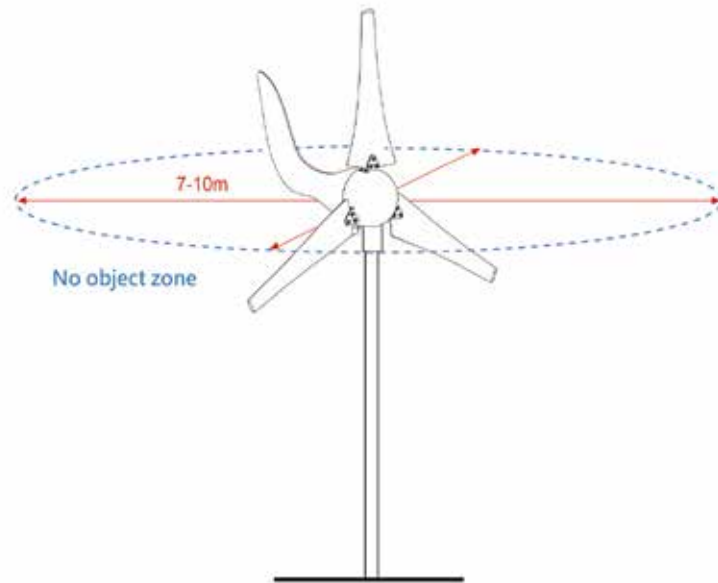

B) Distance from human habitat.

- Install your turbine with some distance from the human activity areas as not to disturb your neighbors and animals around. The noise and vibration element cannot be got rid of even if this wind turbine offers the lowest noise than any others on the market. The better location of your turbine requires avoiding personnel or animal activities within a 33 ft (10 m) radius, and human habitation and wildlife within a 66 ft (20 m) radius.
- The rooftop may not be the best place for your turbine. Here are three reasons.
  - a. The flow is more turbulent above the rooftop and leads to low wind power availability.
  - b. The stress the pole kit sustains varies in rooftop constructions. Evaluation and stability cannot be guaranteed.
  - c. The slight noise and vibration still affect sleep for some sensitive people and animals.

C) Distance between the wind turbine, MPPT controller and battery bank.

D) Any local zoning restrictions.

E) Clearance of power lines or any overhead connection.

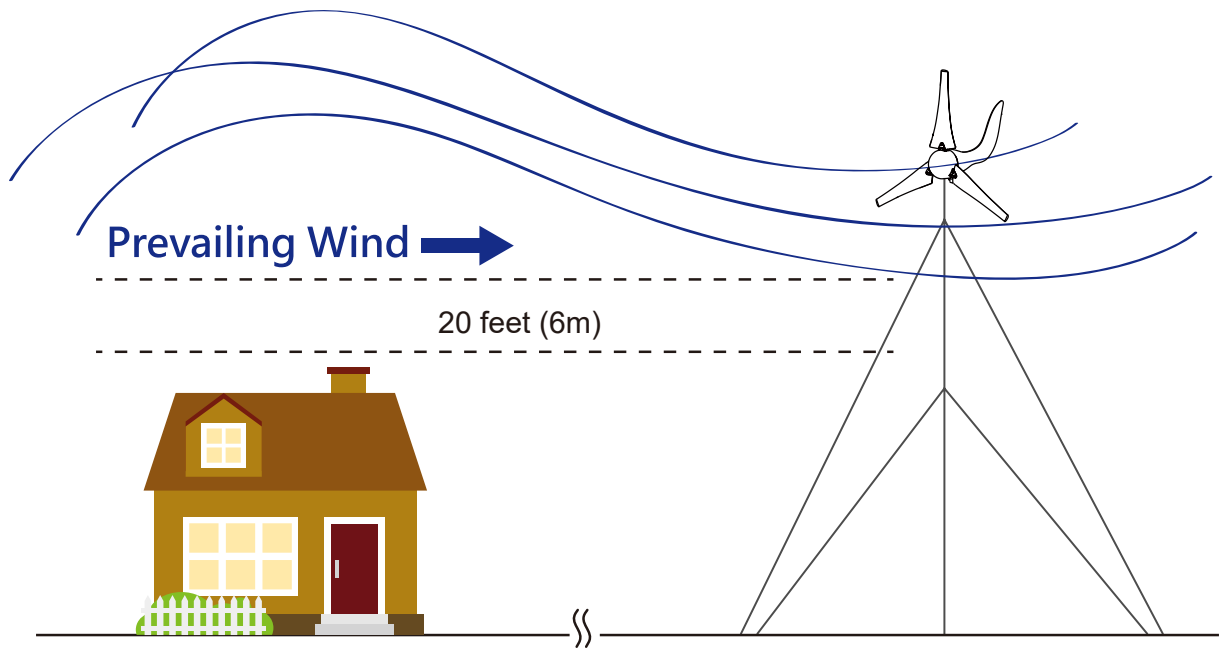

## 2. SYSTEM SPECIFICATION

### 2.1 Specification

Wind Turbine	Model	600 Watt Wind Turbine
	Rated speed	28 mph / 12.5 m/s
	Rated power	600 watts
	Voltage with MPPT	12 volts or 24 volts
	Cut-in wind speed	4.47 mph / 2 m/s
	Survival wind speed	112 mph / 50 m/s
	Rotor diameter	5.6 ft / 1.7 m
	Number of blades	3
	Blade material	glass fiber + pp
	Suggested battery capacity	200 A/HR



\* 12V/24V auto detect: 12V Max. 450W / 24V Max. 600W

\* The Manual stop switch should be activated when the wind speed upwards of 33mph (15 m/s).

\* Survival wind speed means that the wind turbine will survive at 112 mph (50 m/s), when the Manual stop switch is turned on. Exceeding this will result in wind turbine failure and collapse.

## 2.2 Performance

The following power curve shows the performance you should expect from your wind turbine. During smooth, steady wind speed, you can expect to see output resembling the curve illustrated below. To convert between power and current use the following formula:

$$\text{POWER} = \text{VOLTAGE} \times \text{AMPS}$$

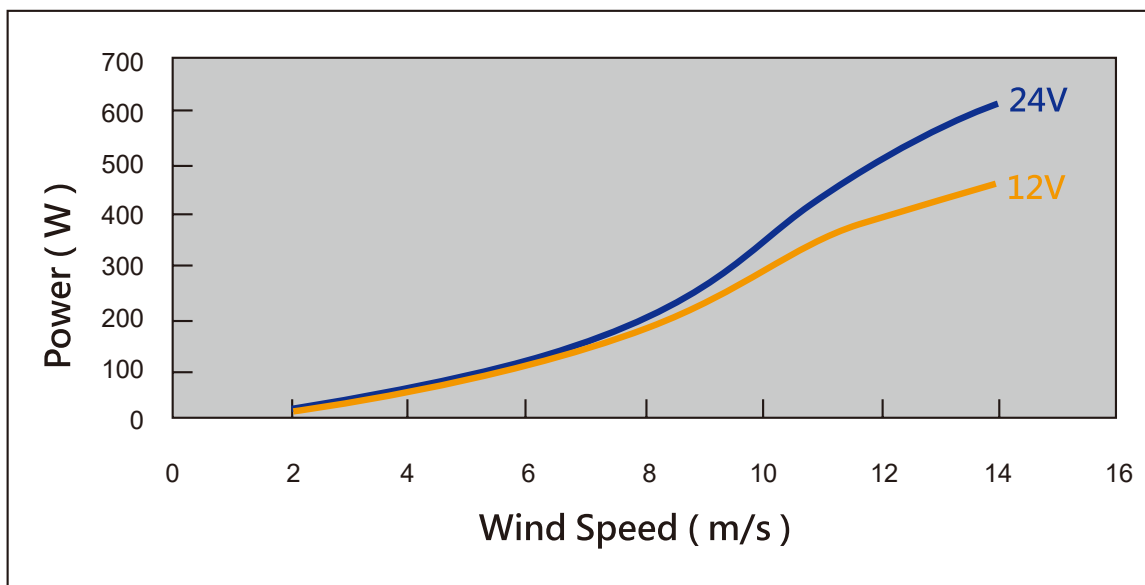

## 2.3 Wiring Requirements

24 / 48 Volt System, AWG / Metric Wire Size mm<sup>2</sup>

<b>Distance between Turbine and MPPT</b>	0 - 30 ft. (0- 9 m)	40 - 70 ft. (9- 22 m)
<b>Wire Gauge</b>	10/6 mm <sup>2</sup>	8/10 mm <sup>2</sup>

Caution1 : Any usage of under-sized wire can be potentially dangerous; our warranty does not cover damages caused by using an incorrect wire gauge. Please review the above wire gauge table to install the correct wires.

We recommend these as the minimum wire sizes for the distance from the MPPT to your turbine.

Caution2: For optimal performance, the distance between wind turbine , MPPT and the battery pack should be kept as low as possible. Distance between wind turbine & MPPT should not exceed more than 30 meters and between the MPPT and the battery pack shouldn't be more than 3 m for safety reasons (Be sure to include the height of the turbine).

Always use the largest gauge wires that are practical and affordable. Local, state, and/or national electrical codes take precedence over these general recommendations.

## System wiring diagrams

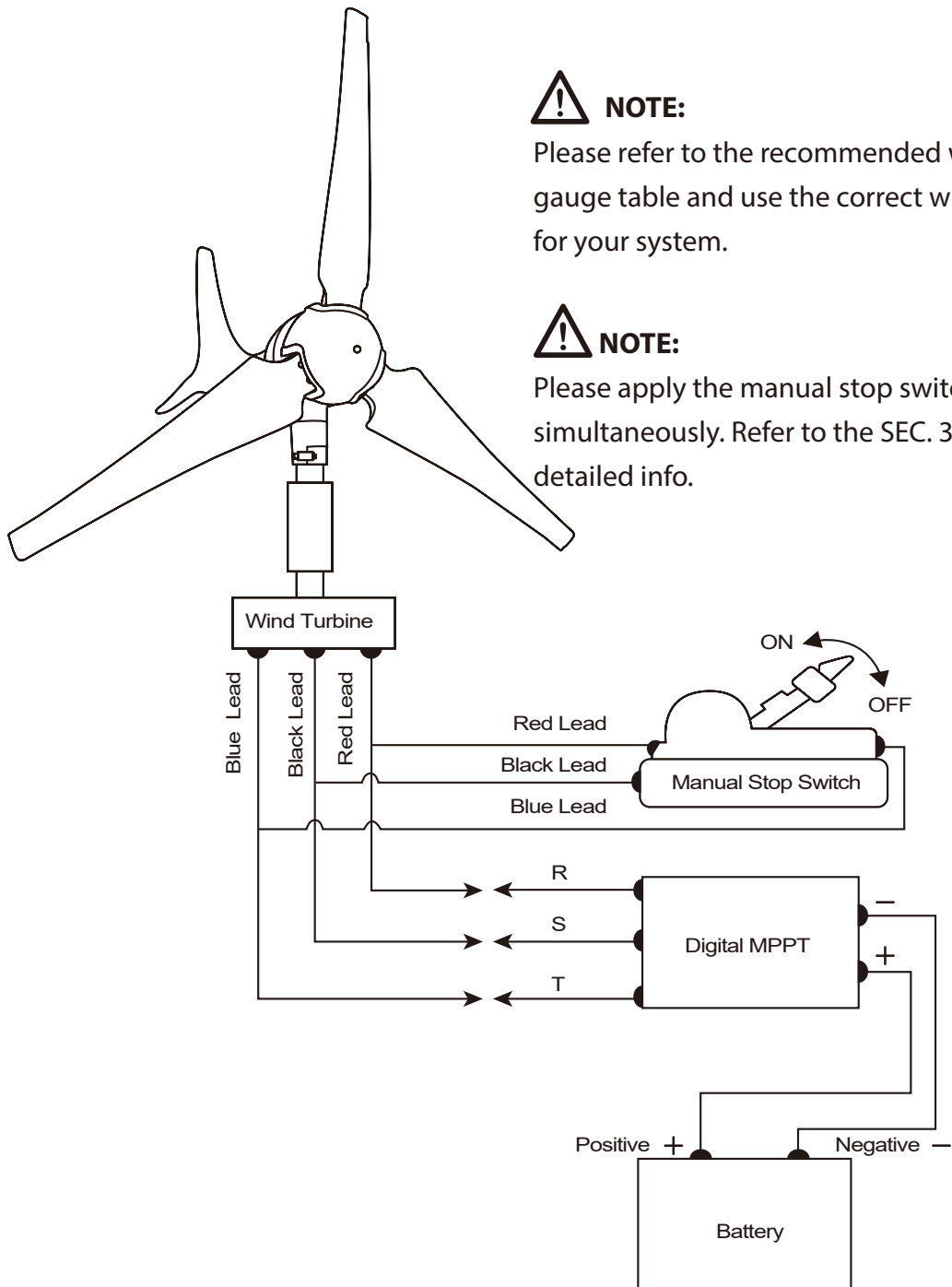

### 3. SYSTEM PROTECTION

#### 3.1 Digital-controlled MPPT

- MCU fully digital-controlled MPPT wind power charger.
- Boost & Buck conversion, large DC input voltage range.
- Smart load management function, braking function.



- (1) Ext. Antenna port
- (2) USB Port
- (3) LCD Display
- (4) LED Indicator (green light: voltage)
- (5) LED Indicator (green light: current)
- (6) Data Port
- (7) SET Button
- (8) Cooling Fan
- (9) RST Cable
- (10) DC Output Cable

## Specification

	12V	24V
Rated Output Power	450W Max.	600W Max.
Battery Voltage Range	10 ~ 15 VDC	15 ~ 29 VDC
Charger Efficiency	95% Max.	
Battery Protection Voltage	14 ± 1 VDC	28.8V ± 2 VDC
Rated Load Current	40A (Max.45A)	
Over-Speed Braking	≥1400 RPM	

## LED indication

PR1	Over RPM Protection	PR5	Low Battery Warning
PR2	High Battery Voltage Protection	PR6	Turbine Overheat Protection
PR3	Over Charging Current Protection	PR7	Wind Gust Protection
PR4	MPPT Overheat Protection		

When the auto protections above occur, the braking will last 3 minutes before the turbines start again.

1. Under normal situations, the green V LED should be lit once connected to a battery.

2. When the SET button is pressed, the green "V" and "I" LED's will be lit alternately, the voltage, current, and total accumulated wattage (kWh) measurements will be shown on the LED screen.

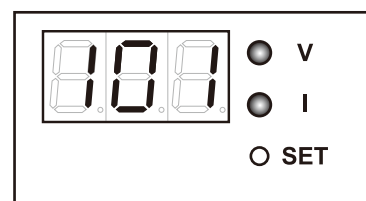
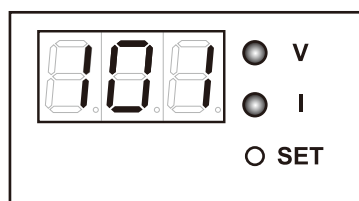
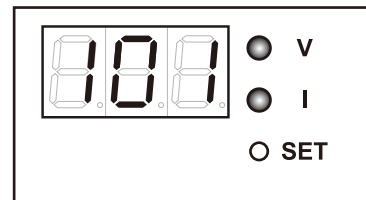
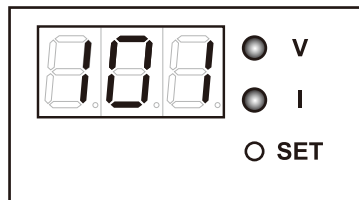
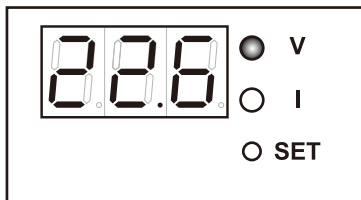

3. If the green V and I LED's flash at the same time, it means that your system is in its protection (brake) mode. To evaluate the problem, further press the SET button, and the LED display will show a set code PR1~PR7. Refer to the description listed above to know what each code stands for.

**System protection:** Your MPPT charge controller, equipped with sensors inside the unit, comes with four main protection functions.

**Self-protection:** The MPPT charge controller has a temperature sensor. The temperature of the internal circuitry is moderated by an internal fan that is activated at 45°C (110°F). When the temperature exceeds 65°C (150°F), the MPPT will apply both the fan and braking system to prevent damage.

**Protection for Battery:** The MPPT charge controller can sense the voltage of the battery and the current output/input to the battery. If the parameter of voltage and current is wrong, then the braking system will be turned on.

**Protection for Wind Turbine:** The MPPT charge controller can sense the rotation speed of the wind turbine. If the rotation speed is over the setting value in the program, the braking system will be turned on. The latest version of the MPPT charger controller has also equipped the phase detector technology. If the AC output waveform from generator is incorrect, that means the generator may be damaged. At that moment, the MPPT will apply the braking system and the LED lamp to warn users.

**Protection for No Battery Connection:** When the MPPT charge controller shuts down due to the abnormal battery and improper connection; it will cause free-spin issues. At 150 RPM and above, the MPPT charge controller should apply the braking system automatically and the power from the wind turbine should be cut off at once. The wind turbine will turn on and brake repeatedly. Under safety conditions, please check the battery wire and function as soon as possible.

### 3.2 Manual Stop Switch

The MPPT controller has an integrated battery controlled braking mechanism. Further to this protection, we have incorporated a secondary level of safety and convenience with a manual 3-phase AC brake. Users can apply the brake using our Windmill Pro app, for more details check the Installation section. During periods of high winds (upwards of 35 mph / 16 m/s) it is strongly advised to utilize App brake and manual stop switch. The App brake derives power from the battery for the brake, so in case of low battery the brake may release. The use of a manual stop switch will not affect the voltage of your battery and is independent of the battery.

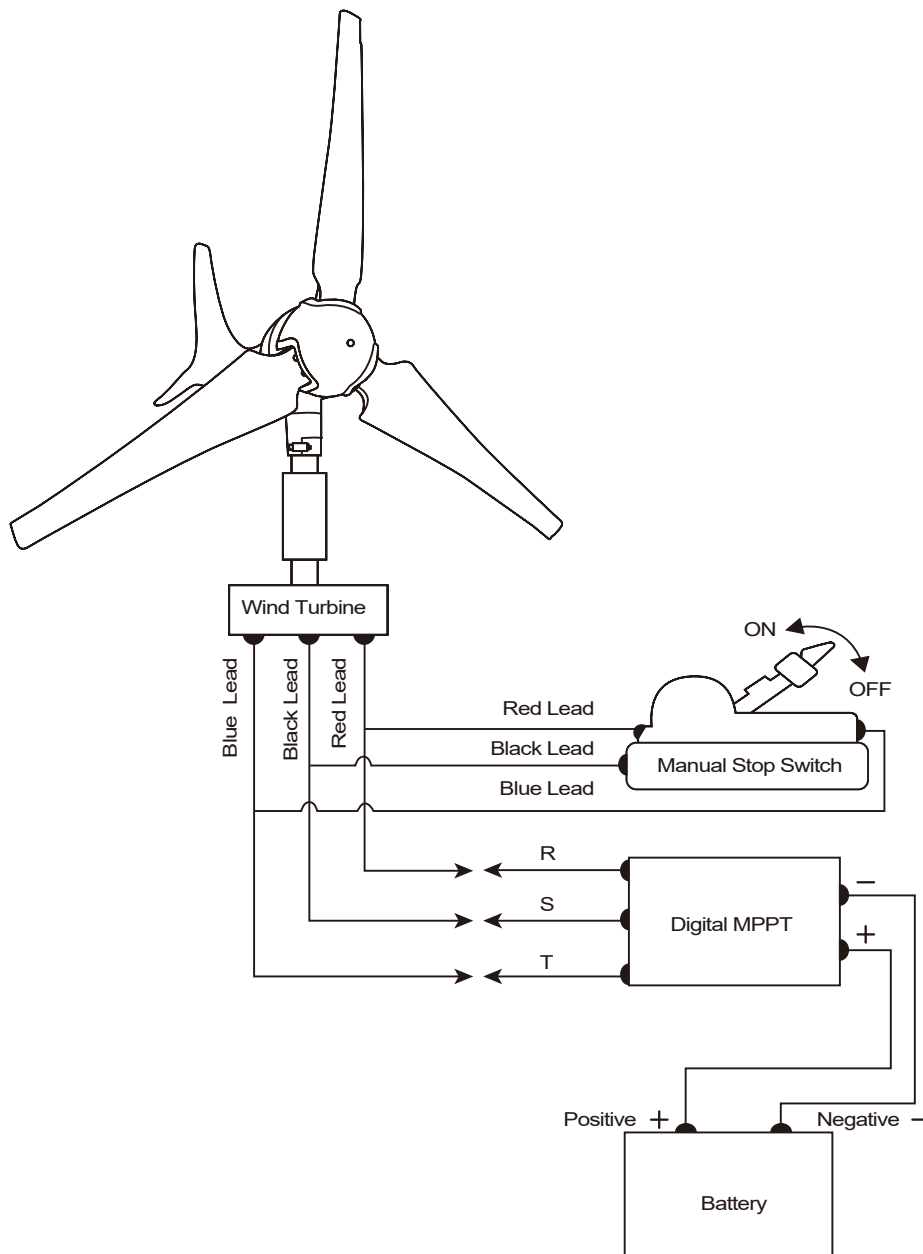

We strongly advise the activation of the manual stop switch during any maintenance of or around your turbine. This will prevent the blades from spinning and voltage to be transferred. Likewise, during initial installation please activate the manual brake. In the final step in the installation of the wind turbine, manual stop switch should be released.

The manual stop switch is pre-wired for your convenience, place the corresponding wires (Red, Black, Blue) from the manual stop switch into the MPPT input terminals. They should be connected corresponding to the color code from your turbine. Wind turbine and manual stop switch share input terminals on the MPPT, this provides a parallel connection.

Test the connection of your manual stop switch at the point of initial installation. Push the brake "ON". You should see the turbine stop its rotation. Continue to apply this brake during the remainder of your installation. Should the turbine continue to spin, check your terminal connections?

**Do not approach the turbine without activation of this manual stop switch under any circumstance!**

- It is strongly advised to test both the manual stop switch and MPPT periodically.
- The manual stop switch is pre-wired, this should not be altered.
- The manual stop switch should be placed close to your MPPT in a dry ventilated environment.
- For multiple turbine applications please use an individual manual stop switch and MPPT controller for each wind turbine.
- This manual stop switch has been designed specifically for your wind turbine; it should not be incorporated into other models.
- Incorrect connections can damage your wind turbine and cause dangers.



## 4. PACKAGE CONTENTS

Check the parts listed with the contents of the box and make sure that you have everything needed for assembly.



*Caution: The edges of the blades are sharp. Please handle with care.*

Part list		Bolt set			
Generator	1	Hex Screw (M6XL40)	9	Washer (M14)	1
Blade	3	Nut (M6)	9	Hex Key No.5	1
Hub	1	Washer (M6)	9	Hex Key No.3	1
Nose Cone	1	Hex Screw (M5XL20)	4	Rubber Spacer	1
Tail	1	Spacer for Tail	4		
Digital MPPT	1	Hex Screw (M5XL50)	1		
Manual Stop Switch	1	Inverse Tooth Nut (M14XP2.0)	1		

## 5. INSTALLATION PROCEDURE

Step 1 : Open the outer and inner boxes to ensure all parts are present.

Step 2 : Carefully observe windmill layer for easy and quick installation.

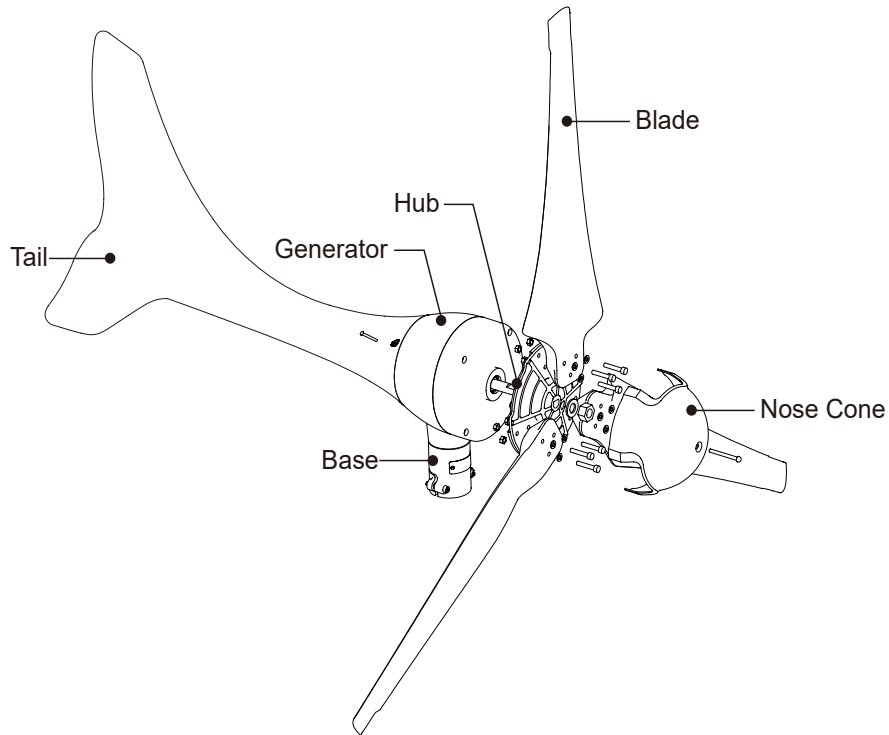

Step 3 : Fasten the blades on the hub with hex screws (M8XL40), nuts (M8), and washer (M8) by using a 6mm hex key.

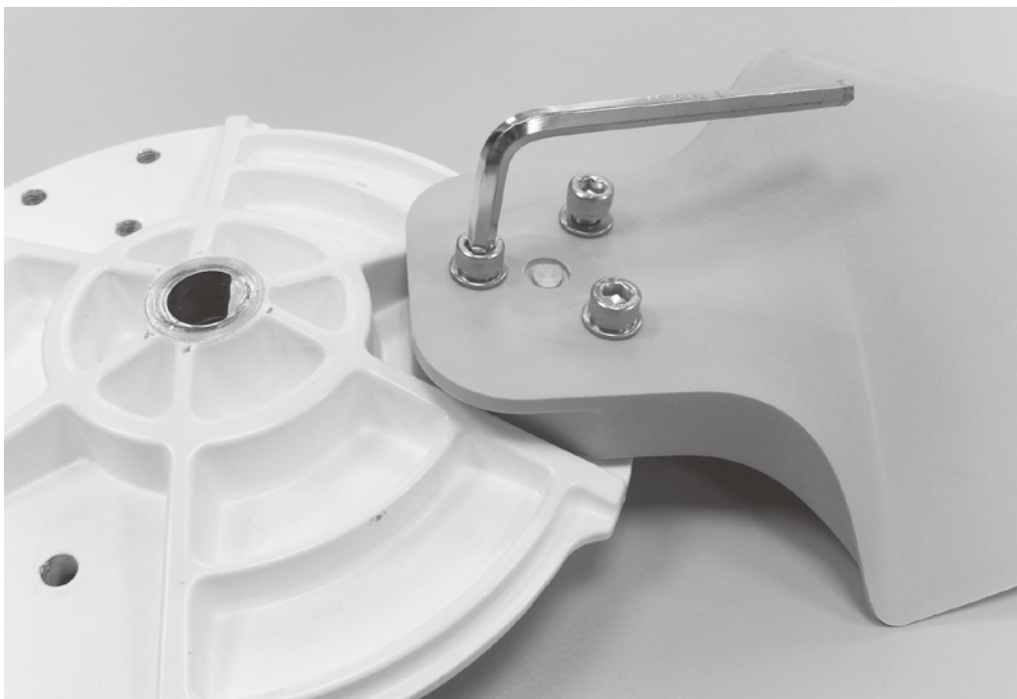



Step 4 : Fasten the blades on the hub with hex screws (M8XL40), nuts (M8), and washer (M8) by using a 6mm hex key.



Step 5 : Tail assembly. Connect the tail to the turbine with 4 x hex screws (M5XL20) and spacers by using hex key no. 3.

Be sure not to over-tighten or it can lead to stripped bolts.

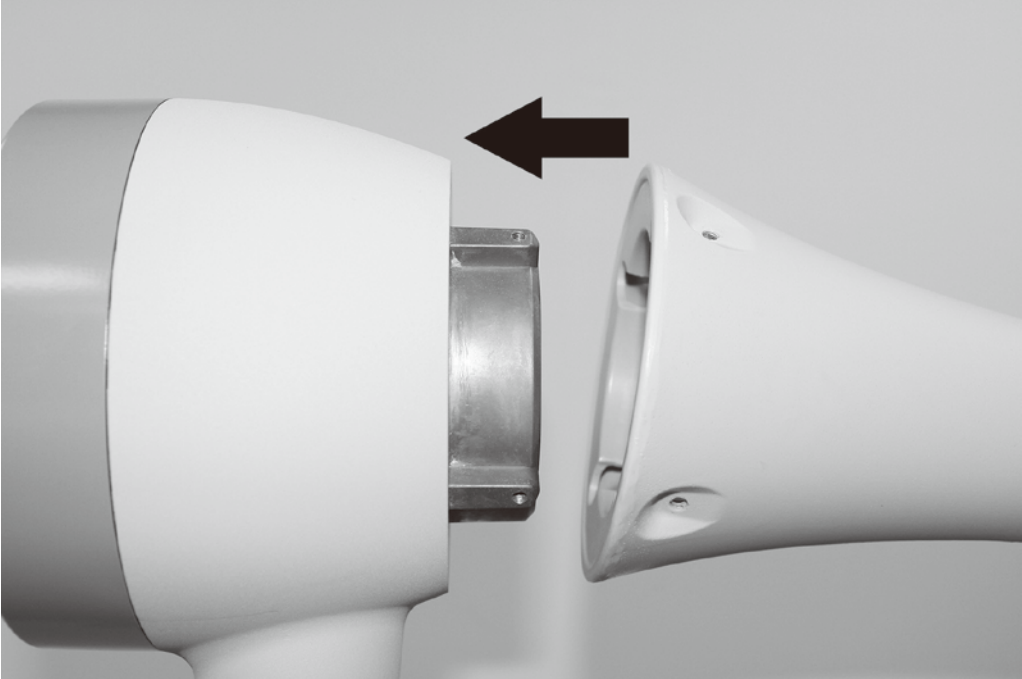

Step 6 : Put the 3 wires (red, black, blue) through the tower. Install the turbine to your chosen tower securely and fasten the bolts by using the hex key no.5.

Rubber spacer should be attached to the tower to increase secure connection to the Yaw Shaft. The outside diameter of the iron pipe should be 48.3 mm, the thickness of iron pipe should be 1.9 mm at least.

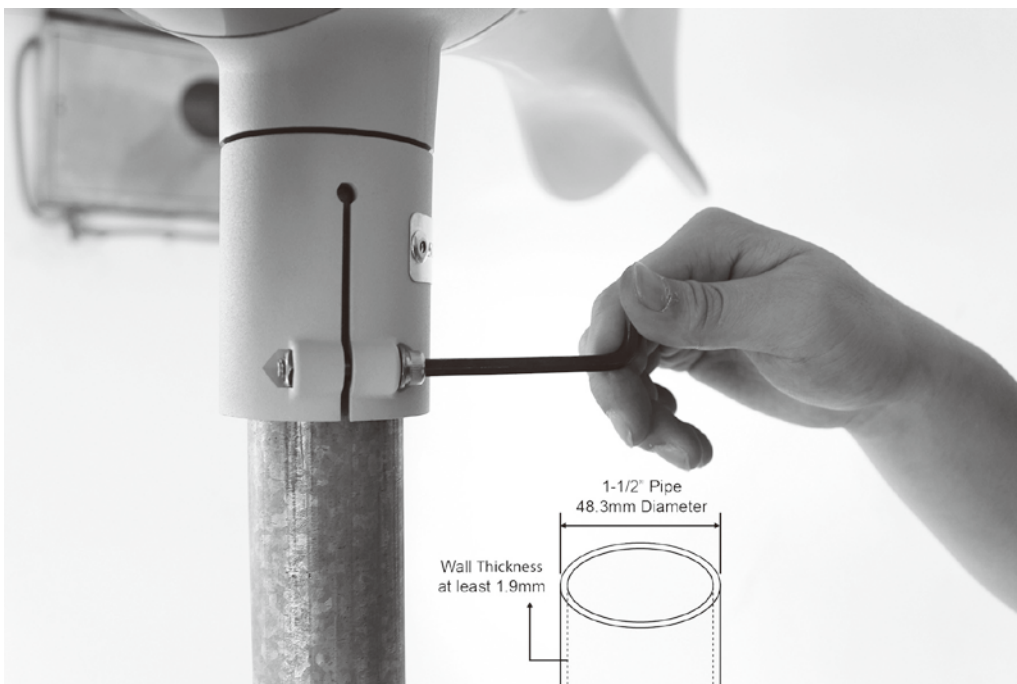

**Caution:** Ensure that rubber spacer is attached to the tower pole prior to turbine installation, otherwise the turbine will be too loose and unable to sustain vibrations.



Step 7 : Install the hub on the turbine with inverse tooth nut (M14XP2.0) and washer (M14).



**Caution:** Make sure the nut is secured with the washer.

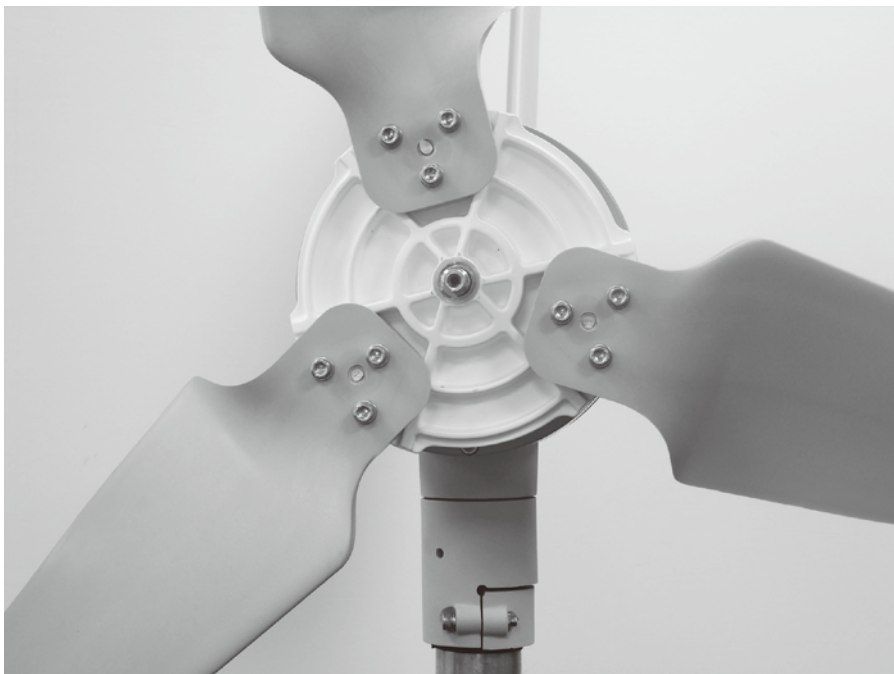

Step 8 : Put the nose cone to the hub. Fasten the nose cone with a hex screw (M5XL50) by using a 3mm hex key.

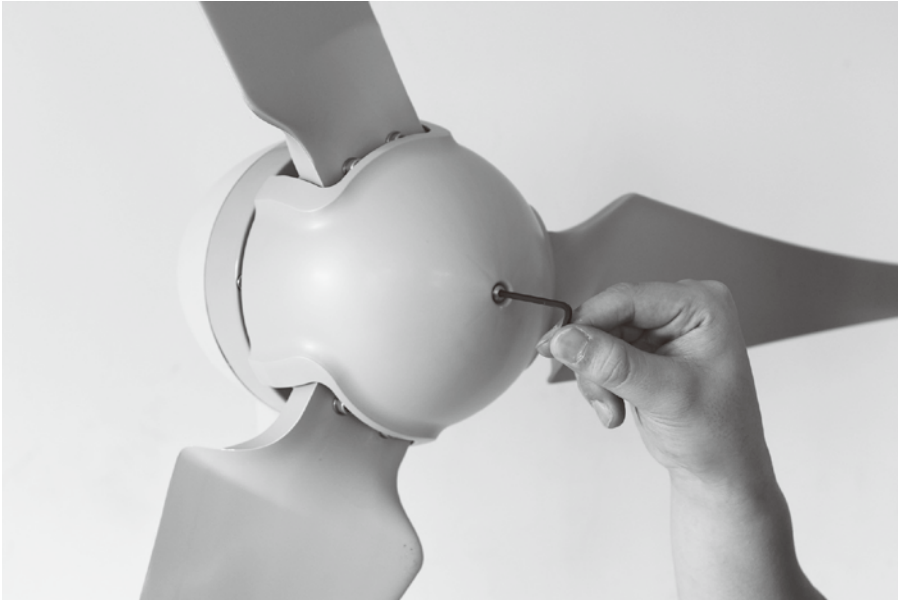

Step 9 : Final product diagram.



**Caution:**

After installing, check and make sure that there is no flange/ coupler/ support cable ring lies within 1.7 m from the wind turbine center/ hub. Cylindrical shape poles are recommended for installing the turbine and there should be sufficient free space/ gap between the pole and the wind turbine blades as, during the wind gust, blades bend a little towards the inside. Refer the image below for a better understanding.

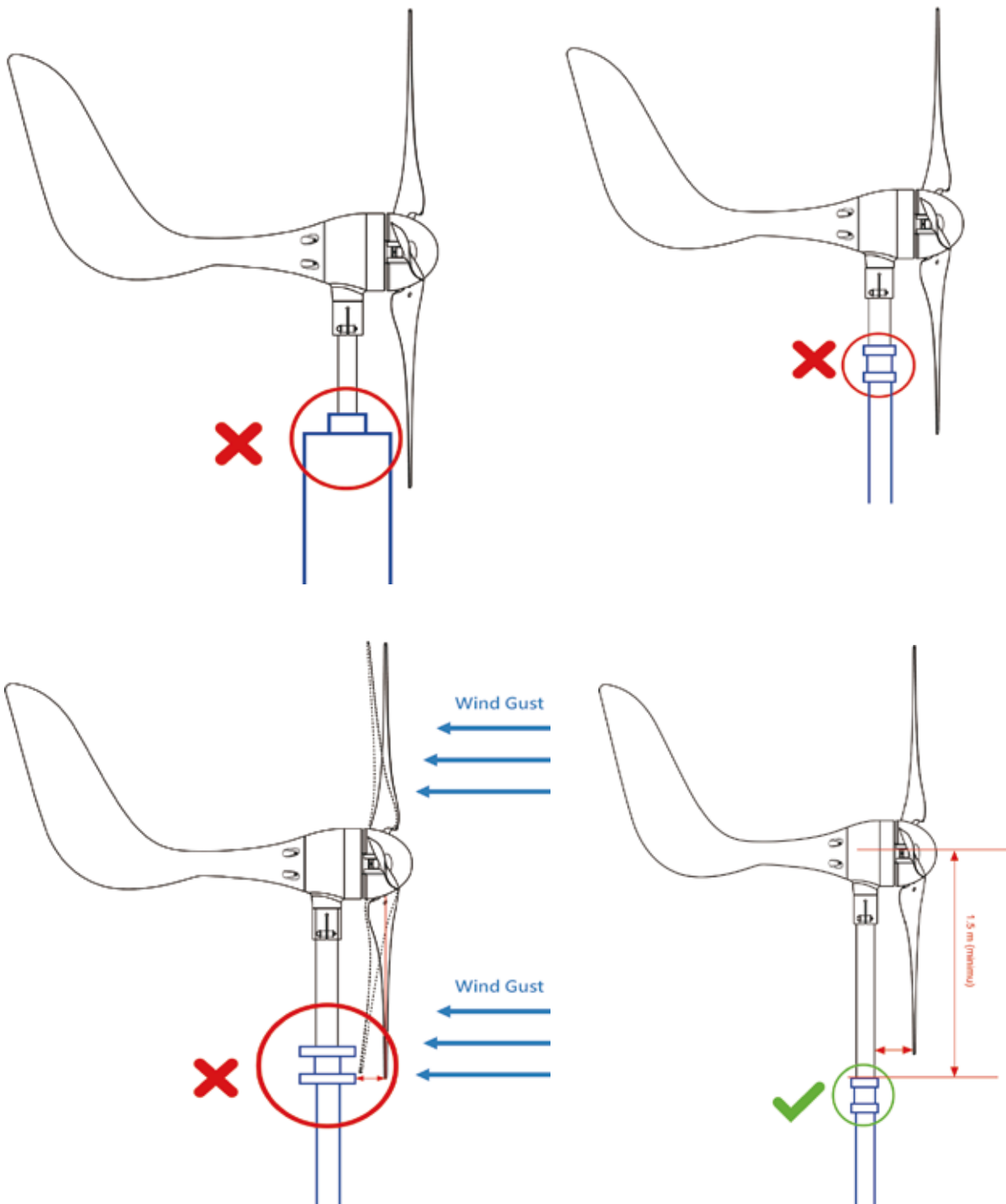



## 6. AUTOMAXX BLUETOOTH APP

You can control and monitor your wind turbine by using our App. You can download the App by scanning the barcode.



You can also download our App by visiting our website, <https://automaxxwindmill.com/support/>

### Introduction to the App

First turn ON the phone/ device's Bluetooth. (No need to enter the device Bluetooth setting for pairing the wind turbine).

- Open the wind turbine App and the wind turbine in the range will show.
- Tap on the wind turbine to connect.
- Once the app is connected with the wind turbine you will reach the home page of the App, which will look like the below picture.



- On top of the home page, the total power generated from the turbine will be displayed.
- The bottom section will provide you information such as the wind blowing, manual brake status, and battery status (Full/ Charging/ Low ).
- Swipe towards the right-side, the graph will provide the real-time voltage available, current, and power generation by the turbine.
- On the bottom of the page, there is a switch to apply/ release the brake to the turbine. This switch can be used to protect the wind turbine in bad weather without being physically present at the manual brake to apply.

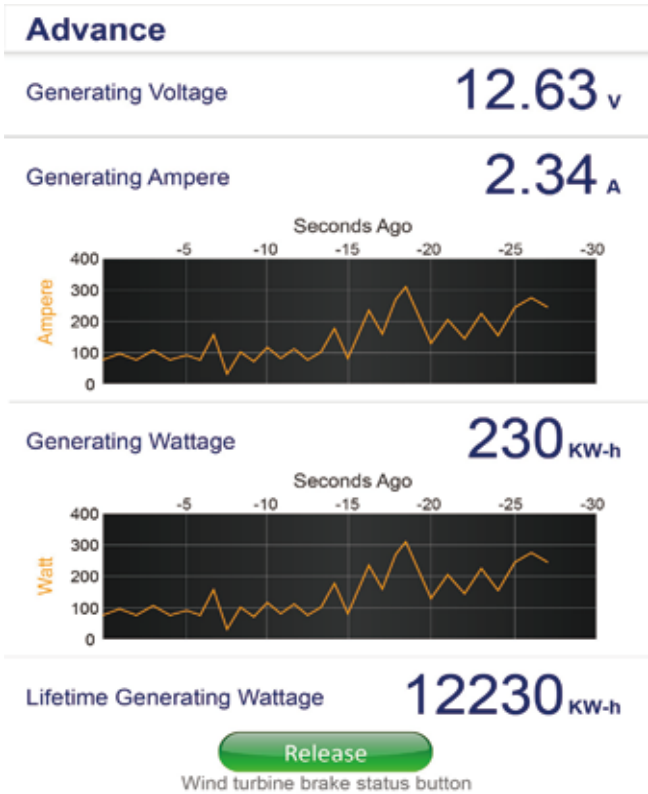

## 7. MAINTENANCE

Your wind turbine has been designed to run for long periods .

The performance will be enhanced if you periodically inspect your system.

Review the following simple maintenance procedures and implement them every six months.

**Caution: Do not go near the wind turbine during operation.**

**The blades are sharp. Please handle it with care.**

- Check blades for superficial damage, replace the blades if damaged.  
It is important to not use blades that are damaged, as you will lose overall balance, resulting in a decrease inefficiency. Should you notice damage to the blades you must replace all 3, these blades are balanced as sets.
- Check the blade bolts and the hub nut for tightness.
- Check nosecone for cracks and tighten nuts.
- Wipe any excess dirt build-up from the blades.
- Check all electrical connections to make sure they are tight and free from corrosion.
- Check the voltage of your battery bank with a Multi-meter and clean the terminals.
- We suggest replacing the blades every five years for optimal performance.

**Note:**

Apply the Manual Brake to safeguard your unit in the mention below situation.

- Bad weather and strong wind
- Maintenance & replacement work
- MPPT failure/ no sign
- Free spinning
- Battery pack disconnected
- Broken Blades
- Mechanical noise
- Notice anything abnormal

## 8. FAQs

(1) How does the wind turbine control power and RPM in high winds?

Your wind turbine's operation will be halted to reduce the risk of damage due to overcharge and over-spin of the rotor blades. This process of braking is handled internally through your MPPT charge controller.

(2) What is the maximum wind speed the wind turbine will survive and do I need to take it down in a storm?

Your wind turbine is designed to operate in most climatic conditions. Should you expect or experience winds of 30 mph (13 m/s) upwards, please utilize your manual stop switch to protect from any over spin. When the wind is getting stronger up to 112 mph (50 m/s) it is necessary to lay down the Tower to offer further protection.

(3) How long will the bearings or other wearing parts last?

According to engineer calculations, the bearings should have a 10-year life span in 6 m/s average wind speed sites. Bearing life will vary from one application to another; however, you should expect at least a 5-year performance in adverse conditions and 10-year in normal conditions.

(4) Can the wind turbine be connected in reverse-polarity to the battery without causing any damage?

Reverse polarity will cause damage to both your MPPT controller and battery if not quickly remedied. Always double check any wiring to reduce the risk of reverse polarity. Your turbine is equipped with polarity protection to reduce the risk of damage, but it is still possible to degrade your wiring and cause damage to the overall system.

(5) Will it hurt my wind turbine to short-circuit the output?

No, the wind turbine is designed to be short-circuited as a normal shutdown procedure by a fuse. The function of the stop switch is to disconnect the turbine from the batteries as well as short-circuit the output of the turbine.

(6) Where can I locate tubing to make a tower?

Your wind turbine is designed to make mounting as simple and straightforward as possible. Should you not wish to purchase the custom tower kit feel free to utilize schedule 48.3 mm steel tubing. This should be available through your local hardware outlet.

(7) What is the difference between copper and aluminum wire?

Generally, aluminum wire is less conductive, so it must be bigger for the same amp load and resistive losses as copper. The wind turbine uses copper or tinned copper for the yaw wires.

(8) What battery should I choose for my wind turbine?

There are multiple battery options in today's market– flooded lead-acid, Absorbed Glass Mat (AGM), Gel cell, NiCad and Lithium-ion. There is no definitive choice for your alternative energy needs. Normally the choice of battery is determined by availability and pricing. Should you have questions regarding batteries please consult a local battery supplier, or view: [www.batterycouncil.org](http://www.batterycouncil.org). The capacity of your battery bank is determined by your use. Below is a good guideline.

- **24-volt systems – 200 Amp-hours**

- **Possible Battery Configurations (suggested)**

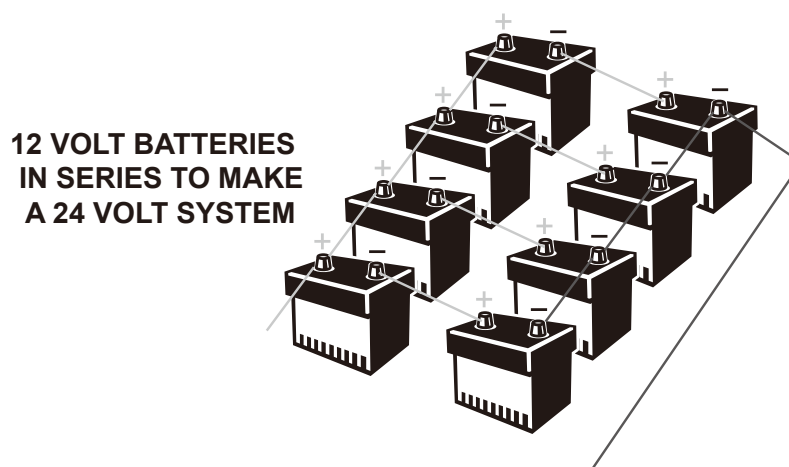

(9) Is lightning protection necessary?

You should ground your wind turbine. Proper grounding (illustrated below) protects individuals to individuals and equipment by eliminating the possibility of dangerous voltage. Remember a steel tower is a conduit for lightning. Every wind turbine and turbine tower needs to be grounded at the tower base even though the system may be grounded at the battery bank. Grounding the tower at its base may help prevent shocks to persons touching the tower due to lightning or electrical faults. Please take the time to review the National Electrical Code (NEC) and local building and zoning regulations for complete requirements. Even in "Off-Grid Systems" there are multiple ways for tower grounding, the most common method is a copper-clad steel electrode(s) driven into the soil. Please view the following grounding diagram.

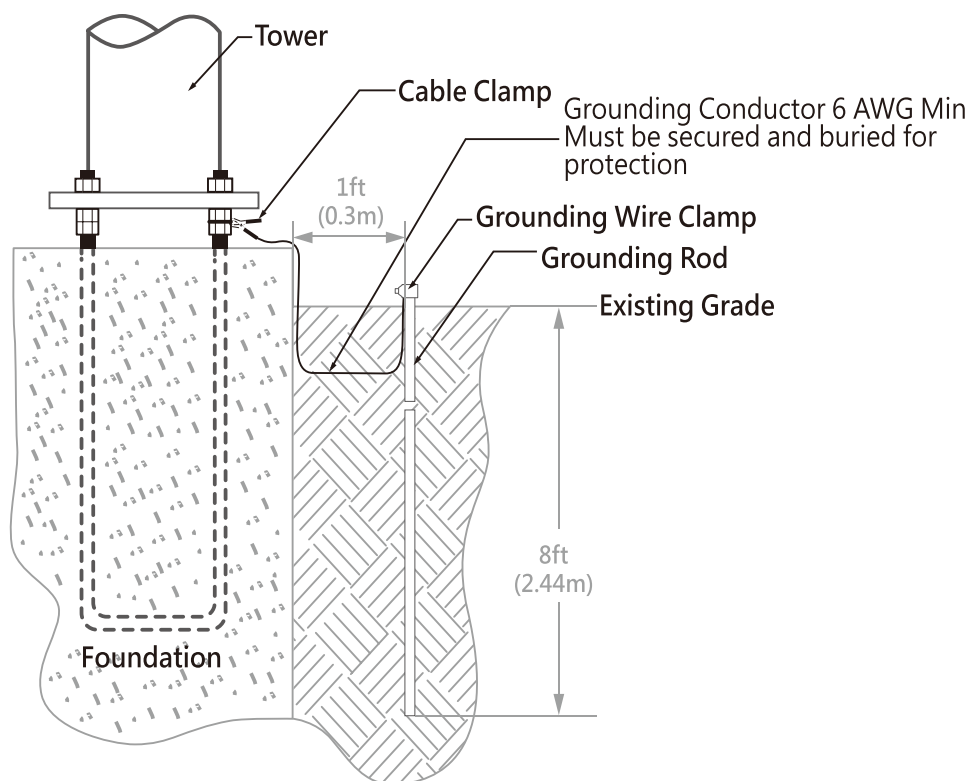

(10) What effect does radio interference have on my wind turbine?

The internal circuitry of the wind turbine is shielded and filtered to prevent radio interference and has been tested to ensure electromagnetic compatibility.

(11) What effect does my wind turbine have on radio transmissions?

The wind turbine normally does not affect radio transmitters. Care should be taken, however, to route power lines from the wind turbine away from the power and antenna lines of a radio transmitter. An old ham radio operator's trick is to twist positive and negative wires together to provide an even distribution of EMF noise across both wires, which serves to cancel out the electrical noise created.

This technique can be used on the wind turbine power lines, on the radio's power lines, and transmission wires. Transmission lines should always be kept as far from power lines as is practically possible. Proper grounding of the wind turbine and other system components must also be observed.

(12) Will it affect the regulation of my wind turbine to install an RF (radio frequency) filter?

An RF filter should not affect the regulation of the wind turbine, but any electronic devices placed in line with the turbine must be rated for the proper current and voltage. It is best to place any line filters on the power lines for the load device that requires it, and as close to the device as possible.

**For more latest FAQ's, checkout our website: <https://automaxxwindmill.com/faq/> or Scan the QR Code:**



## 9. TROUBLESHOOTING

You may require an extra person to assist with these tests.

**We strongly advise the activation of the manual stop switch during any maintenance of or around your turbine. This will prevent the blades from spinning and voltage to be transferred.**

(1) Remove the blade/hub from the turbine. Replace the rotor hub nut on the rotor shaft.

(2) Quickly spin the rotor shaft manually with your fingers while connecting and disconnecting the red and black wires (the turbine must not be connected to batteries).

(3) With the red and black wires connected, the shaft should be more difficult to turn. When the wires are disconnected it should spin freely. Should this not be true please contact the supplier or manufacturer.

(4) With your wind turbine connected to your battery bank, use an electric hand drill to spin the rotor shaft.

(5) Below 500 RPM, the rotor should spin freely without friction.

(6) At 500 RPM and above, the wind turbine should be charging the battery. You should feel resistance on the rotor shaft if the shaft is not rotating; contact your turbine dealer or manufacturer. Be aware your battery banks needs to be under 24V or 48V for this testing as the turbine needs to read a charge.



## **AUTOMAXX WARRANTY POLICY**

In the unlikely event that anything goes wrong with your purchase. Don't worry, we've got you covered! You're protected by our **1-Year Manufacturer's Warranty Policy**.

### **General**

We warrant your product to be free from defects in material and/or workmanship for 1 year from the original date of purchase. Warranty coverage is extended only to the customer (Special case/ request decided before the sale of the unit or reward). If the product proves defective during the warranty period, Automaxx option will be:

1. Replace wind turbines with a new or refurbished product.
2. Repair or replace the defective part.

The customer's warranty continues to be valid on repaired or replaced products from the original warranty date.

### **Warranty Period**

The Automaxx warranty valid for the period of one year (365 days) after the date of first purchase. If proof of purchase cannot be provided, the manufacturer date as recorded by Automaxx will be deemed to be the start of the Warranty Period.

### **What is covered and what's not?**

All Automaxx products and accessories that are purchased from Automaxx website/Authorized partners are covered for one year.

The warranty covers defects in manufacturing discovered while using the product as recommended by the manufacturer. The warranty does not apply to:

1. Product, equipment, or accessories that not purchased from the Automaxx / Authorized Partners.
2. Product that has been tampered with, repaired, modified or altered other than by manufacturer or without prior manufacturer's approval.

3. Damage to the Product caused by windstorms (upwards of Beaufort Wind Scale 7), lightning and Hail damage.
4. Damage to the Product caused by improper installation, negligence, accidents damage, misuse, or abuse.
5. The serial number of the Product, components or accessories has been altered or removed.
6. The Warranty seals have been broken or altered.
7. Fraud, theft, unexplained disappearance, or damages / detrimental circumstances caused by a willful act of the customer.
8. All acts of God

Any service identified in the above list or product is found not to have any defect in manufacturers' workmanship or materials the customer will be responsible for the costs of all repairs and expenses incurred by the manufacturer.

*If the Product is under Warranty, You hereby agree to transfer the ownership of replaced defective parts/ accessories and such parts shall automatically become the property of Automaxx and returned to Automaxx for inspection.*

### **Customer Responsibility When using the Product**

1. Read the user manual first and use the product according to the user manual.
2. Please check the manual and the Automaxx website for troubleshooting solutions, if you notice something abnormal/ unusual with the product, contact the local supplier / distributor or contact Automaxx customer service.
3. Keep the original packaging. In case the Product needs to be returned for repair/ replacement, original packaging provides a better protection for the Product during transportation.
4. Contacting Automaxx customer service, Fill the investigation form and describe the problem clearly.

### **Initiating a Return**

Simply fill the investigation form and contact your local supplier or our customer service support at <https://automaxxwindmill.com/contact/>.

**You will be given an RMA (Return Merchandise Authorization) number which is required to process your return.**

1. Send all the parts, spare parts, accessories & documents that were originally available with the unit.
2. Just keep in mind that returned products must be in usable and resellable condition with all the accessories. We cannot accept items damaged due to accident, misuse, abuse or negligence.

**Shipping Your Return/ Replacement to Automaxx**

1. Simply fill the investigation form and send our Customer Care Center at <https://automaxxwindmill.com/contact/>.
2. A RMA number will be provided to you, write your RMA number on the outside of the package.
3. RMA numbers make it easy for us to identify your package and process your return. Packages sent without an invoice or RMA number cannot be processed. Please include the printout of the investigation form, Purchase Invoice with your return.
4. We recommend adding tracking and insurance to your return shipment. We can't be responsible for packages lost by your shipping carrier, so make sure you're covered. It's cheap and worth it.
5. You are responsible for the cost of shipping the product back to us.
6. Automaxx have no liability for the loss, damage or destruction of items within the package during shipment.

**Refund Amount and Processing Time**

We refund you the product price, which is the your total order amount minus shipping costs. Please allow 5 business days from the time we receive your return to process your refund. We will issue your refund back to the PayPal you used at the time of purchase. If we have your email address on file, we will send you an email confirmation when we receive your return and when we refund your order.

### **Out Of Warranty Cases**

Sending the Product to Automaxx repair center does not automatically mean that it will be repaired free of charge. Upon receiving your product, Automaxx reserves the right to check the validity of your warranty and your request for warranty service. If the warranty period has lapsed or if any of the exclusions previously mentioned, your request will be deemed out of warranty ("OOW"). If your service request is OOW, a service charge list with an offer for repair will be provided to you, which you may accept or reject. If you accept, repair we will provide you with an invoice for the repair labor, spare parts and other costs stated in the Service Charge List. You must pay the invoice within 4 weeks of the invoice's date of issue. The repair will only be completed after the invoice is settled.

### **International Warranty**

*Warranty only applies in the country of purchase only.*

### **Abandoned Property**

After your product has been repaired / replaced, or if you do not agree to the repair offer, Automaxx will return your repaired / replacement product via post. In case of failed delivery attempt due to wrong address/ unavailability of attendee/ other, Automaxx will send you an email provided at the point of service request. If you still fail to pick up the product within a period of 15 days from sending the notice. Automaxx reserves the right to claim damages from you, including the cost of storage; to dispose of product in accordance with the applicable laws and regulations; and any statutory right of lien for unpaid charges.

### **Disclaimer**

Under no circumstances Automaxx will be liable or responsible for any loss of use, interruption of business, lost profits, lost data, incidental or consequential damages of any kind regardless of form, resulting from the defect, repair, replacement, shipment.

## APPENDIX A IMPORTANT SAFETY INSTRUCTIONS

Read these instructions below before installing your wind turbine to ensure people and property against accidents. Please also make sure it is set up under environmental and operating conditions.

1. Install the wind turbine in open and windy sites. So, the turbine will be exposed to winds properly and the benefit can be maximized. A distance of 7-10m should be maintained. The noise and vibration element cannot be got rid of even if wind turbine offers the lowest noise than any others on the market. The better location of your wind turbine requires avoiding personnel or animal activities within a 33 ft (10 m) radius, and human habitation and wildlife within a 66 ft (20 m) radius.

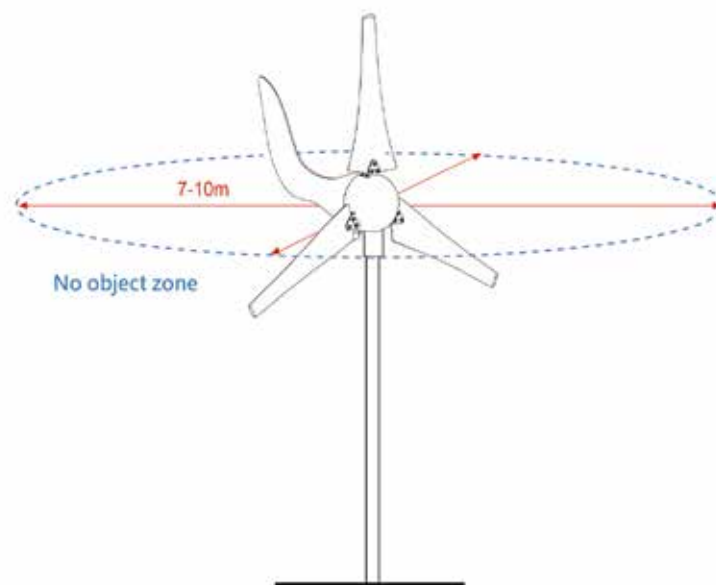

2. The height of installation should be 22 ft (7 m) to 33 ft (10 m). The wind speed below 22 ft (7 m) constrained by the terrain is low and chaotic. For example: If winds in your area are more than 30 mph (13 m/s), a height of 7 m is recommended. The higher the wind turbine stands (more than 10 m), the more stress your pole kit will sustain. Also, the wind turbine possibly brakes in extreme weather conditions.

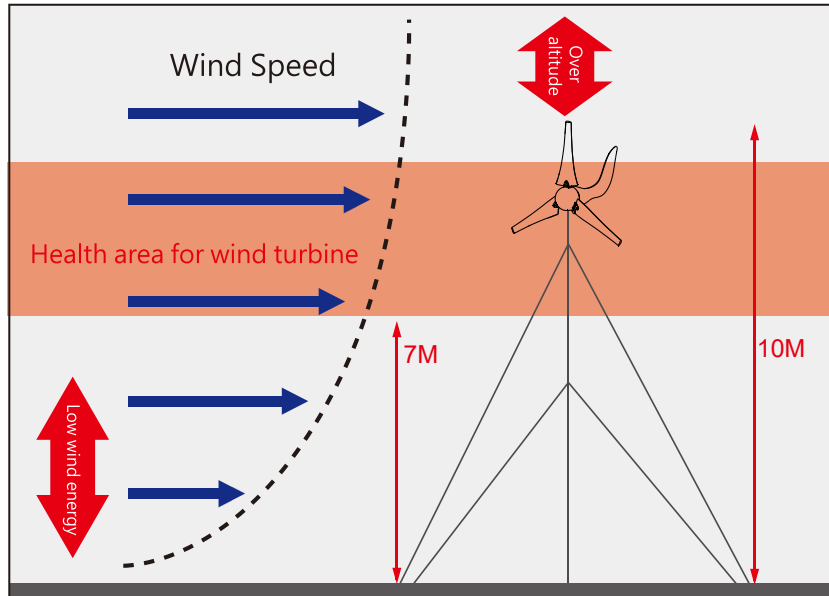

**Caution:**

After installing, check and make sure that there is no flange/ coupler/ support cable ring lies within 1.7 m from the wind turbine center/ hub. Cylindrical shape poles are recommended for installing the turbine and there should be sufficient free space/ gap between the pole and the wind turbine blades as, during the wind gust, blades bend a little towards the inside. Refer the image below for a better understanding.

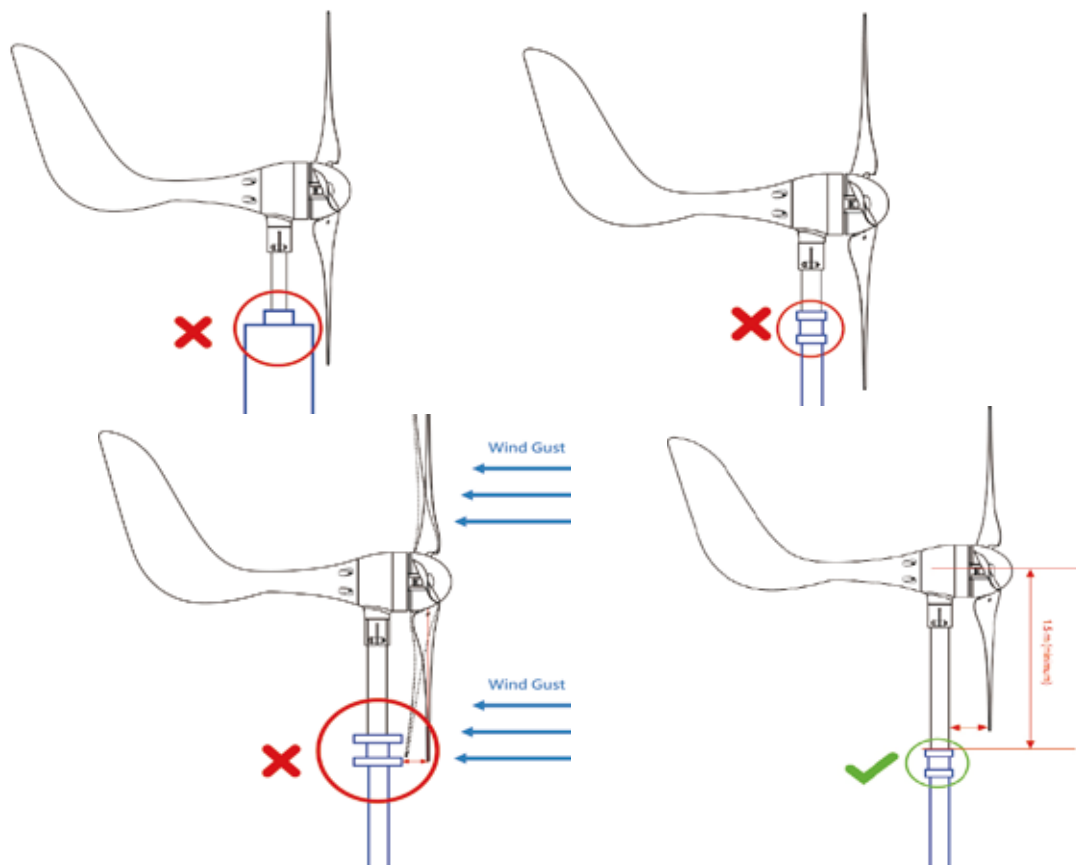

### **Operating Environment:**

A. Operating Temperature: -4°F (-20°C) ~ 122°F (50°C)

B. Operating Humidity: < 80%

C. Average Wind Speed: < 34MPH (<15 m/s or <54KMH)

D. Max. Peak Wind Speed: < 45MPH (<20m/s or <70KMH)

E. Elevation: < 1000m

F. Applicable Installation Height: 8.85ft~33ft (2.7m~10m)

*It is subject to IEC 61400-2 safety standards. If the operating temperature and wind speed exceed the above-mentioned limits, turn on the manual brake in a proper way to shut off the turbine.*

3. The rooftop may not be the best place for your wind turbine.

Here are three reasons.

a. The flow is more turbulent above the rooftop and leads to the low wind power availability.

b. The stress the pole kit sustains varies in rooftop constructions.

The evaluation and stability cannot be guaranteed.

c. The slight noise and vibration still affect sleep for some sensitive people and animals.













4. Check the three wires from the wind turbine output periodically. Please check AC current from your MPPT. If the outputs are not consistent, please contact the distributor for further instruction. For safety reasons, please stop operating your wind turbine.

5. Check the battery health periodically. The abnormal battery and improper connection will cause over-spin issues. The wind turbine's operation should be halted to reduce the risk of damage due to over-spin of the rotor blades.

6. Check the battery health periodically. The abnormal battery and improper connection will cause over-spin issues. The wind turbine's operation should be halted to reduce the risk of damage due to overspin of the rotor blades.

7. Survival wind speed means that the wind turbine will survive 112 mph (50 m/s) when the manual brake is turned on. Exceeding this stated wind speed will result in wind turbine failure and collapse.

## APPENDIX B BEAUFORT WIND SCALE

Beaufort No.	Description	Avg. Wind Speed (knot/h)	Avg. Wind Speed (km/h)	Avg. Wind Speed (m/s)	Avg. Wind Speed (mi/h)	image
0	Calm	<1	<2	<0.55	< 1.24	
1	Light air	1 – 3	2 - 6	0.55~1.66	1.24~3.73	
2	Light breeze	4 – 6	7 – 12	1.95~3.33	4.35~7.46	
3	Gentle breeze	7 – 10	13 – 19	3.61~5.27	8.08~11.81	
4	Moderate breeze	11 – 16	20 – 30	5.55-8.33	12.43~18.64	
5	Fresh breeze	17 – 21	31 – 40	8.61-11.11	19.26~24.85	
6	Strong breeze	22 – 27	41 – 51	11.38~14.16	25.48~31.69	
7	Moderate gale	28 – 33	52 – 62	14.45~17.22	32.31~38.53	
8	Fresh gale	34 – 40	63 – 75	17.5~20.83	39.15~46.60	
9	Strong gale	41 – 47	76 – 87	21.11~24.16	47.22~54.06	
10	Storm	48 – 55	88 – 103	24.44~28.61	54.68~64.00	
11	Violent storm	56 – 63	104 – 117	28.88~32.5	64.62~72.70	
12	Hurricane	≥ 64	≥ 118	>32.77	> 73.32	

It is strongly advised to manually turn on your Mechanical Stop Switch during periods of high winds (upwards of Beaufort Wind Scale 7)



## **APPENDIX C MPPT CHARGE CONTROLLER**

### **600W Digital MPPT Charge Controller**

An MPPT, or maximum power point tracker is an electronic AC to DC converter that optimizes the match between the turbine and the battery bank, DC motor, or DC pump. (These are usually called power trackers or MPPT's for short. The power output of a wind turbine varies almost directly with the amount of wind - but the voltage and current do not. The current drops off much faster than the voltage. Under low wind conditions the panel or turbine may be putting out higher volts, but the amperage will be lower than the unit's rating.

### **What does a Maximum Power Point Tracker (MPPT) do?**

An MPPT controller looks at the output of your wind generator and compares it against the battery voltage. It then uses an algorithm to calculate the absolute best power that the wind turbine can put out. The MPPT controller then converts its findings to the best possible voltage to allow for maximum AMPS running into the battery bank. Most MPPT controllers are at 92-97% efficient however the controller is 97-99% efficient in the conversion. Here is where the optimization or maximum power point tracking comes in.

### **Overview**

The Maximum Power Point Tracking (MPPT) charge controller enables the wind turbine to achieve its highest possible performance by periodically tracking the Maximum Power Point of the turbine. The MPPT can be used with battery systems from 12V or 24V DC. The MPPT set points are fully adjustable to allow use with virtually any battery type, chemistry, and charging profile. This user guide will demonstrate the basic operation and troubleshooting of your MPPT charge controller.

## Wiring

The three output wires from the wind turbine are Blue / Red / Black and transform three-phase AC. The three wires need to be connected to the “RST” terminal located on the back of the digital MPPT charge controller. (Three-phase power is a method of electric power transmission using three wires) . The manual stop switch is pre-wired for your convenience with 10 AWG wire and battery terminal connections. Place the corresponding wires (red, black, blue) from the manual stop switch into the MPPT input terminals. This should match the similar colored wires from your turbine. Your turbine and stop switch share input terminals on the MPPT. This provides a parallel connection. (see figure below).

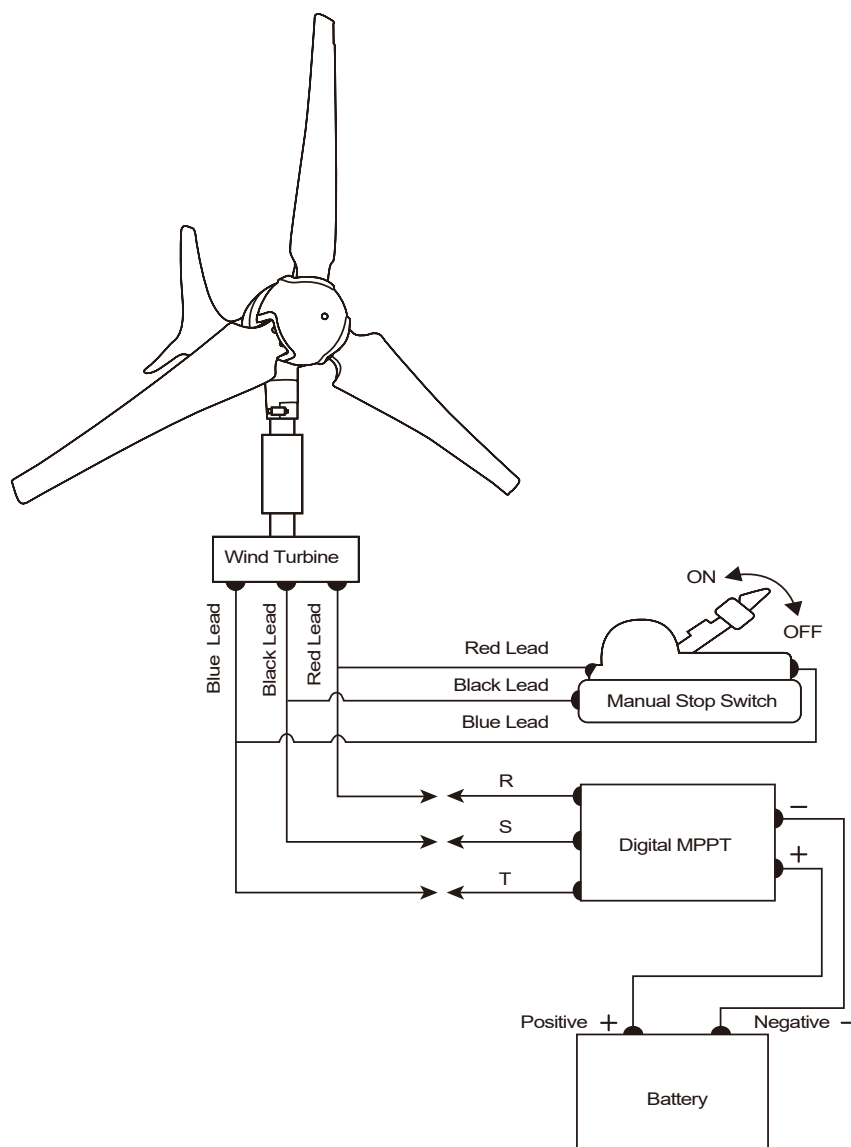

## Function

- (1) Ext. Antenna port
- (2) USB Port
- (3) LCD Display
- (4) LED Indicator (green light: voltage)
- (5) LED Indicator (green light: current)
- (6) Data Port
- (7) SET Button
- (8) Cooling Fan
- (9) RST Cable
- (10) DC Output Cable

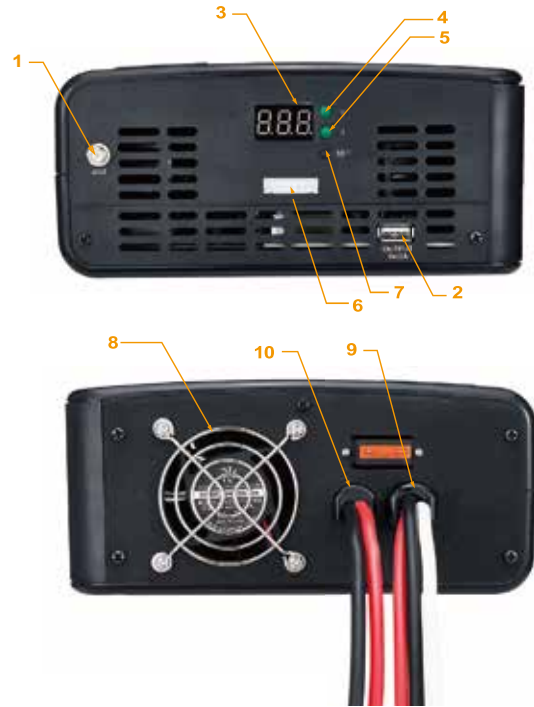

<b>MPPT LED INDICATION</b>	High Battery Voltage Protection	MPPT Overheat Protection	Turbine Overheat Protection
High RPM Protection	Over Charging Current Protection	Low Battery Warning	Wind Gust Protection

- [ PR1 ] High RPM Protection
- [ PR2 ] High Battery Voltage Protection
- [ PR3 ] Over Charging Current Protection
- [ PR4 ] MPPT Overheat Protection
- [ PR5 ] Low Battery Warning
- [ PR6 ] Turbine Overheat Protection
- [ PR7 ] Wind Gust Protection

1. Under normal situations, the green “ V ” LED should be lit once connected to a battery.
2. When the “ SET ” button is pressed, the green “ V ” and “ I ” LED’s will be lit alternately, the voltage, current and total accumulated wattage (KWH) measurements will be shown on the LED screen.

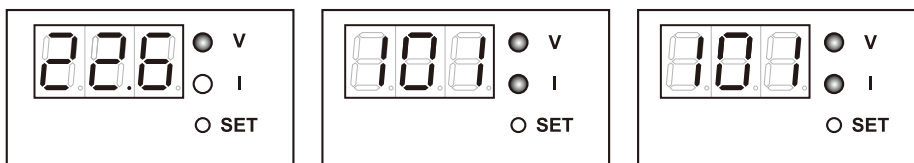

### **Suggested Battery Charger Set points:**

The battery manufacturer should provide you with specific instructions on the following maintenance and charging regulation set point limits for the specific batteries. The following information can be used when the manufacturer's information is not available. Note: Higher settings can be used with non-sealed batteries, but water consumption will be greater and excessive temperatures when charging may occur.

#### **Sealed Lead Acid – AGM GEL 12V 24V**

ABSORB voltage set point 14.3V 28.6V

FLOAT voltage set point 13.6V 27.2V

#### **Non-Sealed Lead Acid 24V 24V**

ABSORB voltage set point 14.8V 29.6V

FLOAT voltage set point 13.6V 27.2V

### **Multi –Stage Battery Charging**

The MPPT charge controller is a sophisticated multi-stage battery charger that uses several regulation stages to allow fast recharging of the battery system while ensuring a long battery life. This process can be used with both sealed and non-sealed batteries. The MPPT will automatically set the charging regulation voltage set points (absorb & float) for the selected nominal battery voltage, however, always follow the battery manufacturer's recommended charging regulation voltages. The MPPT charging regulation stages correspond to the chart below.

#### **Bulk**

This stage provides the maximum power to the battery -- voltage increases while charging.

A bulk charge is automatically initiated when the battery voltage is below the absorb and float voltage set points. The bulk charge will continue until the absorb voltage set point is achieved.

## **Absorbing**

This stage limits the amount of power going to the battery -- the voltage is held constant. The absorb charge will continue for the duration of the bulk cycle or until the 2 hours (default) absorb time limit is reached. For example, if a bulk charge takes 1 hour to reach the absorb voltage set point then the absorb charge will continue for 1 hour as well. However, if a bulk charge takes 3 hours to reach the absorb voltage set point then the absorb charge will last for 2 hours only. A bulk charge will be re-initiated if the battery voltage is not sustained at the absorb voltage set point.

## **Float**

This stage reduces the charging voltage to prevent overcharging of the batteries. A float charge follows after the absorb charge is completed. The MPPT will not re-initiate another bulk charge if the float voltage set point is not sustained, however, it will continue to charge the battery until the float voltage set point is achieved. Note: A bulk charge can be initiated if the battery voltage falls below the float voltage set point if the re-bulk (ReBV) voltage option is set.

## **Understanding the various modes**

The modes of operation will change occasionally during the day based on the turbine's output and battery system state of charge. The MPPT operating modes are displayed through the LED.

## **Sleeping**

Happens when the wind turbine's voltage is less than the battery voltage or charger current is below the minimum cutoff (Low cutoff) current. This may also appear briefly during the day when the MPPT is transitioning between certain states, and because of other conditions.

## **Absorb**

There is an external DC source (wind generator/hydro) keeping the battery at or above the absorb set point.

## **Wakeup**

As the turbine's open circuit voltage (Voc) rises above the battery bank's voltage by approximately 2 volts, the MPPT controller gets ready to work to deliver the best possible power to the batteries. During this period, the MPPT is calculating the PWM (Pulse-width modulation) duty cycles by turning on power supply voltages in the proper sequences, and making internal calibrations. At wakeup, the MPPT closes its relays and will then start sweeping the input voltage, (the "initial" sweep), towards the battery voltage. This may happen numerous times at both dawn and dusk until there is enough power from the turbine to keep charging the battery bank. Wakeup is also a time when the MPPT controller acquires a new Voc.

## **Sweeping**

In Auto-Sweep MPPT mode, the MPPT is either doing an initial sweep of the turbines voltage from Voc towards battery voltage after wakeup, or is doing a periodic dithering mini-sweep to stay on the max power point. Below 5 amps of battery output current, this will flash briefly as the MPPT operates at the Park MPP voltage. This signal may also appear briefly if the MPPT has reached the max battery current setting and is raising the turbines operating voltage to keep the battery current from exceeding the maximum battery output current limit setting.

## **Absorb**

There is an external DC source (wind generator/hydro) keeping the battery at or above the absorb set point.

## **Bat Full**

The MPPT is waiting for the battery voltage to fall to just below the float voltage set point before continuing with the float stage. This may also be displayed when external DC charging sources are present.

## **Re-Cal**

There are certain abnormal conditions that can confuse the current measuring method in the MPPT. When and if this happens, the MPPT will temporarily stop and re-calibrate. This may sometimes happen because of negative current, i.e.,

and re-calibrate. This may sometimes happen because of negative current, i.e., current coming out of the input terminals instead of into the input terminals turbine breaker. A new voc is also acquired during a Re-Cal.

## **TROUBLESHOOTING**

MPPT does not boot / power-up

1. Check battery connection and polarity. Reverse polarity or improper connection will cause power-up issues.
2. Check if the battery voltage is greater than 6V. A battery voltage less than 14V may not power up the MPPT.

MPPT is inactive

1. Is battery voltage greater than the absorb voltage set point (compensated absorb voltage)?  
If yes, the MPPT will not wake up since the battery voltage is at / above the absorb target voltage set point.
2. Is the wind turbine's voltage greater than the battery voltage by at least 2 volts?  
The output voltage has to be at least 2 volts greater than the battery voltage for the initial wakeup.
3. Check the turbine's breaker (or fuse) to ensure that the turbines breaker (or fuse) is sized appropriately.

### **MPPT not producing expected power**

1. Are wind conditions optimal?  
Wind turbines in locations with constantly high wind speeds bring the best return on investment. The primary consideration in a wind generator is the average wind speed at the installation site. A different turbine will give optimum performance at a site with average wind speeds below 15mph than one at a site with speeds in the low 20mph range.
2. Are the batteries charged? Is the MPPT in the absorbing or float stage?  
If so, the MPPT will produce enough power to regulate the voltage at the absorption or float set point voltage, therefore, requiring less power in these modes.

### 3. What is the short circuit current of the wind turbine?

Use a multimeter to determine if a short circuit current is as expected.  
There might be a loose / faulty wire connection.

### 4. Is the turbine's voltage close to the battery voltage?

If so, the panels could be warm/hot causing the Maximum Power Point of the array to be at or lower than the battery voltage.

## MPPT sweeping frequently

### 1. What is the current limit set point?

When the current limit set point is achieved the MPPT will continue sweeping to maintain the targeted current limit.

### 2. What is the sweep interval set point?

A short sweep interval time will cause the MPPT to sweep frequently.

A sweep interval of 7 to 10 minutes is recommended.

## MPPT Internal Fan

Should the internal fan be running when the MPPT is producing power?

The internal fan will only run when the internal temperature has reached ~ 65 degrees Celsius or 149 degrees Fahrenheit.

## Downloadable APP for Bluetooth Function



You can also download our App by visiting our website, <https://automaxxwindmill.com/support/>





# Investigation Form

RMA No. \_\_\_\_\_

## Purchase Details

Name:	Purchase Date:
Email:	Phone No.:
Order ID:	Model/ Product:
Event Date:	Location:

Please fill out the following questions for further investigation.

1. The wire length between the wind turbine and the MPPT \_\_\_\_\_ m/ ft,  
MPPT and the battery \_\_\_\_\_ m/ ft.
2. Wire Gauge (AWG) or metric wire size used \_\_\_\_\_ mm<sup>2</sup>
3. Connected battery (Lead Acid/ AGM/ Gel/ LiFePO<sub>4</sub>) capacity \_\_\_\_\_ Ah
4. Average wind speed \_\_\_\_\_ Mph/ m/s
5. The tower height: \_\_\_\_\_ ft or \_\_\_\_\_ m
6. Suspect Components to be damage or faulty (MPPT/ Wind Turbine/ Manual Brake)
7. Issues Type (Low power/ Heating/ Mechanical Noise/ MPPT Protection)
8. With loads connected: Yes or No. Which load you are using? \_\_\_\_\_.
9. Issues Details

10. Incident Photos/ Videos / Other supporting materials

[www.automaxxwindmill.com](http://www.automaxxwindmill.com)

[Infinitemalltd@gmail.com](mailto:Infinitemalltd@gmail.com)

WhatsApp +866-0905067973









